



# Compagno™ 2

## Bluetooth® Keyboard with Carrying Case



Model: WKB-2000CD

# QuickGuide

English

www.adesso.com

①

### CONTENTS



A Keyboard and Case

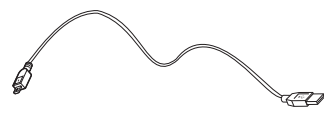

B Micro USB Cable



C Quick Start Guide

### DESCRIPTION

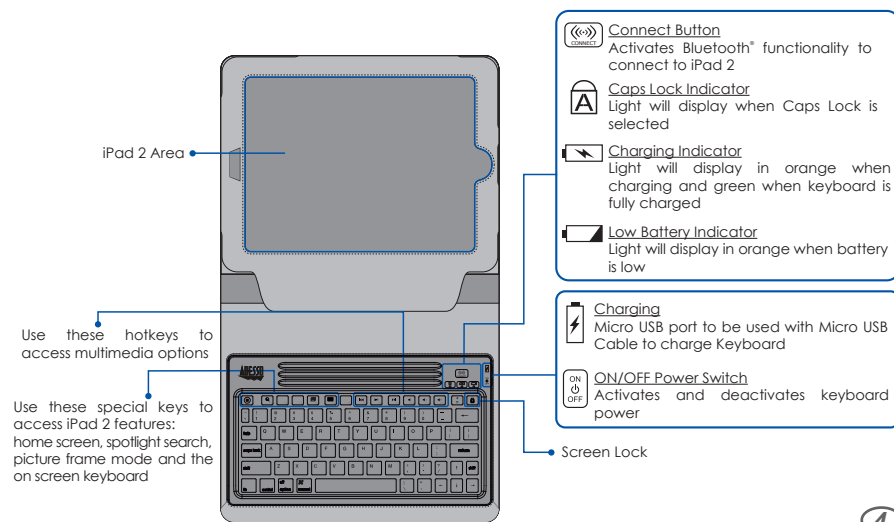

④

### CHARGING BATTERY

Charge keyboard battery using computer USB port or any USB power adaptor (i.e. iPad charger):

- Insert the Micro USB Charging Cable Connector into the keyboard micro USB charging port, located on right side of keyboard.  
**Note:** Insert Micro USB Cable with battery charging symbol facing up, as shown below.

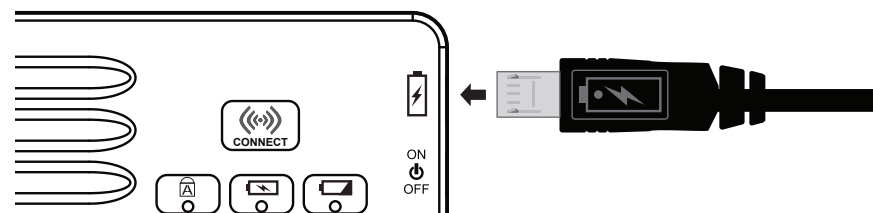

- Insert the USB end of the Micro USB Cable into the USB port of your computer or any USB power adaptor.

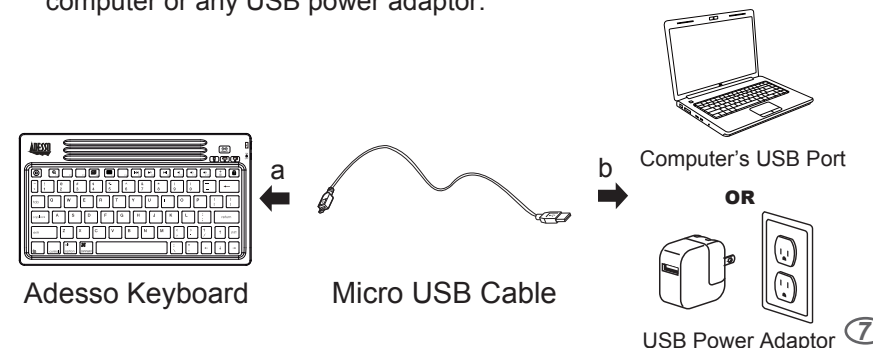

⑦

### LIMITED WARRANTY

Adesso provides a one year limited warranty for all of its products against defects in material and workmanship.

During this period, Adesso will repair or replace any product which proves to be defective. However, Adesso will not warranty any product which has been subject to improper freight handling, shipping abuse, neglect, improper installation or unauthorized repair. The warranty will not cover products installed with components not approved by Adesso and products where the sealed assembly trace has been broken.

If you discover a defect, Adesso will, at its option, repair or replace the product at no charge to you provided you return it during the warranty period with freight charges pre-paid to Adesso. Before returning any product, you must obtain a Return Merchandise Authorization number (RMA). This RMA # must be clearly marked on the outside of the package you are returning for warranty service. Be certain to also include your name, shipping address (no PO Boxes), telephone number, and a copy of the invoice showing proof of purchase in the package.

### SUPPORT

We have listed most of our FAQ's (Frequently Asked Questions) at: <http://www.adesso.com/faqs.asp>. Please visit our FAQ Service & Support pages before you contact our E-mail or Telephone Support.

**Email Support:** If our FAQ's do not help you resolve your issues, please email [support@adesso.com](mailto:support@adesso.com)

**Telephone Support:**  
Toll Free: (800) 795-6788  
9:00AM to 5:00PM PST Monday - Friday

②

### INSTALLATION

- Open and insert your iPad 2 into the case as shown below.
- Fold flap behind iPad 2 screen to secure iPad 2 in place.

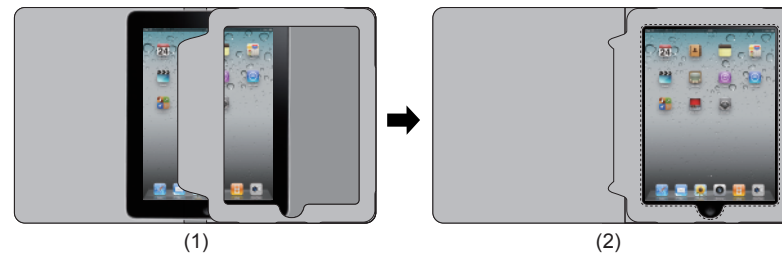

### BLUETOOTH CONNECTION SETUP

- Turn **ON** your iPad 2 and set Adesso Keyboard Power Switch to **ON**.
- Press **CONNECT** button on Adesso Keyboard to make Bluetooth® signal discoverable.

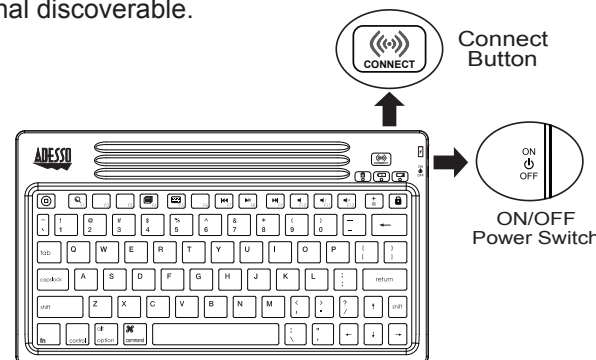

⑤

### NOTE:

- The Charging Indicator will turn orange during the charging period and then green once keyboard is fully charged.
- The keyboard goes to sleep mode after 5 minutes of inactivity. If leaving your keyboard for more than an hour, keyboard Power Switch should be set to OFF to save battery life.

### TROUBLESHOOTING

If your keyboard does not work after installation, please try the following:

- Make sure you have turned the Power Switch to ON at the side of the keyboard.
- Make sure you have set up Bluetooth connection correctly on your iPad 2 as instructed on Bluetooth Connection Setup (pg. 5,6).
- Make sure that the keyboard is within range of your iPad 2. Maximum keyboard Bluetooth range is 30 feet.
- Make sure that both your iPad 2 battery and the keyboard battery are fully charged.

⑧

### INTRODUCTION

The Adesso Compagno™ 2 detachable Bluetooth® keyboard and case are the perfect companions for your iPad 2™. This sleek and stylish detachable Bluetooth® keyboard includes a standard layout with iPad™ and Multimedia Hotkeys, to access iPad 2™ shortcuts with one-touch. The keyboard is designed with a silicon material that protects it against spills and water, while also providing a fast and almost silent tactile response. A contemporary faux leather case accompanies your keyboard to protect your iPad 2™ from the unexpected. This case not only protects, but it also provides multiple viewing angles for easier typing, Internet browsing, and video viewing. In addition, the Compagno™ 2 case design gives your two iPad 2™ cameras full visibility and includes a magnetic closure that automatically wakes and sleeps your iPad™ when you open or close the case.

### SPECIFICATIONS

- Keyboard: 76-Key Mini Layout
- Wireless Technology: Bluetooth® 2.1 Connectivity
- Working Range: 30 feet (10M)
- Battery: Polymer (Rechargeable)
- Battery Life: Up to 100 hours (continuous use) / Up to 30 days (standby mode)
- Keyboard Dimensions: 9.25 x 5.25 x 0.30" (235 x 133 x 7mm)
- Case Dimensions: 7.65 x 9.65 x 1.20" (195 x 245 x 30mm)
- Combined Weight: 1.45 Lbs (660g)
- Case: Faux Leather

### REQUIREMENTS

- Bluetooth® 2.1, 2.0, and 1.1 wireless technology

③

- Select iPad 2 **Settings**, then **General** and **Bluetooth** option, slide the iPad 2 Bluetooth toggle to **ON**. After a few seconds **Adesso Bluetooth Keyboard** will appear in list of Bluetooth devices, select keyboard.



- A screen will show asking to pair Adesso Bluetooth keyboard, using Adesso Keyboard enter the **randomized passkey** provided on screen and press return. Upon completion, your iPad 2 screen will show the keyboard connected and will be ready for use.

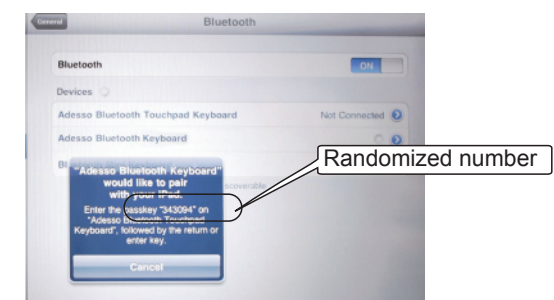

⑥

### FEATURES



#### Detachable Bluetooth® Silicon Keyboard is Wireless, Waterproof, Silent and Fast

This detachable Bluetooth® keyboard offers the freedom to use your keyboard at any angle and with other Bluetooth® enabled devices. The silicone material used in this keyboard will protect it against spills and let you wash it regularly, to keep it germ free. Unlike other silicone keyboards, the rigid backing on the Compagno™ 2 keyboard provides a fast response, while the tactile key switches are almost silent.



#### Manage E-mails and Browse the Internet

The Adesso Compagno™ 2 keyboard and case are design to make e-mail management, Internet browsing and other typing activities comfortable and productive. This case and keyboard combination provide the same great feeling of a laptop, so you can comfortably respond to e-mails, communicate on social media, and browse the internet for hours.



#### View Slideshows and Movies

The Adesso Compagno™ 2 case offers the flexibility to use case without keyboard, providing an additional viewing angle. Simply take out your keyboard and instantly you have a relaxing position to view slideshows, videos, and movies hands-free! This viewing position also keeps your iPad 2™ securely in place, so you can safely use the touch-screen.

⑨